



**BURG  
WÄCHTER**

Letter boxes made of plastic, stainless steel, steel & solid cast aluminium  
Banks of letter boxes  
US-Mailboxes, paper boxes  
Letter plates, letter boxes for sealing in the wall  
Freestanding letter boxes



Letter boxes



**BURG  
WÄCHTER**

## Letter boxes made of high-quality plastic



Bremen 885 GR

### Bremen

The top-model made of high-quality plastic with integrated paper box, improved stylistic.

Art.-No.	Colours	EAN	H x W x D	Slot
		40 03482...	mm	W x H (mm)
<b>885 W</b>	white	12590 8	320 x 420 x 155	330 x 30
<b>885 GR</b>	green	12560 1	320 x 420 x 155	330 x 30
<b>885 BR</b>	brown	12570 0	320 x 420 x 155	330 x 30



### Kiel

The Kiel - stylish and handy! Well-designed letter box made of high-quality plastic with integrated compartment for newspapers. Big volume, comfortable letter insertion.

Art.-No.	Colours	EAN	H x W x D	Slot
		40 03482...	mm	W x H (mm)
<b>886 W</b>	white	12800 8	400 x 380 x 178	325 x 34
<b>886 Si</b>	silver	07830 3	400 x 380 x 178	325 x 34
<b>886 GR</b>	green	12920 3	400 x 380 x 178	325 x 34
<b>886 BL</b>	blue	12910 4	400 x 380 x 178	325 x 34
<b>886 S</b>	black	12790 2	400 x 380 x 178	325 x 34



Kiel 886 W



Siena 886 Terra

### Siena

A real gem for mediterranean flair at your door. Weatherproof. Stable. Comfortable slot and removal of letters. With integrated paper box.

Art.-No.	Colours	EAN	H x W x D	Slot
		40 03482...	mm	W x H (mm)
<b>886 Terra</b>	Terra	11990 7	400 x 380 x 178	325 x 34



# Letter boxes made of high-quality plastic



Impression 898 GT Post

## Impression

The letter box with the lifestyle shape surprises with an unusual shape and practical details. The new colour "graphite" goes perfectly with stainless steel, aluminium, wood or light-coloured fronts. Integrated compartment for news-papers.



Art.-No.	Colours	EAN	H x W x D	Slot
		40 03482...	mm	W x H (mm)
<b>Post 898 GT</b>	graphite	01640 4	391 x 420 x 150	330 x 32
<b>Linea 898 GT</b>	graphite	09890 5	391 x 420 x 150	330 x 32
<b>Punto 898 GT</b>	graphite	09900 1	391 x 420 x 150	330 x 32



Motiv Punto



Motiv Linea

## Malmö

Contemporary soft design. Made of high-quality plastic, includes paper box.

Art.-No.	Colours	EAN	H x W x D	Slot
		40 03482...	mm	W x H (mm)
<b>889 W</b>	white	18350 2	330 x 420 x 170	325 x 33
<b>889 FB</b>	light-blue	19140 8	330 x 420 x 170	325 x 33



Malmö 889 W



Atlanta 4901 W

## Atlanta

Fancy upright format plastic letter box.

Art.-No.	Colours	EAN	H x W x D	Slot
		40 03482...	mm	W x H (mm)
<b>4901 W</b>	white	32300 7	461 x 386 x 160	260 x 34
<b>4901 S</b>	black	32310 6	461 x 386 x 160	260 x 34
<b>4902 PR Si</b>	silver	32340 3	461 x 386 x 160	260 x 34





**BURG  
WÄCHTER**

## Letter boxes made of high-quality plastic



Swing 4905 W

### Swing

New compact letter box completely made of plastic. Attractive form. Simple functionality.

Art.-No.	Colours	EAN	H x W x D	Slot
		40 03482...	mm	W x H (mm)
<b>4905 W</b>	white	05330 0	419 x 271 x 129	261 x 39
<b>4906 PR Si</b>	silver	05470 3	419 x 271 x 129	261 x 39



### Swing-Set

Post box Swing made of plastic – now with fitting paper box. Appealing shape – harmonious impression. Technically perfect construction. Extremely weatherproof. With integrated opening stop, easy post removal. Paper box 4900 also available separately.

Art.-No.	Colours	EAN	H x W x D	Slot
		40 03482...	mm	W x H (mm)
<b>49050 W</b>	white	32710 4	419 x 271 x 129	261 x 39
<b>49060 Si</b>	silver	32720 3	419 x 271 x 129	261 x 39



Swing-Set  
49060 Si



Swing-Set 49050 W



Classico 4932 Si

### Classico

Letter box made of plastic in a soft shape. Can be placed everywhere. Extremely weatherproof.

Art.-No.	Colours	EAN	H x W x D	Slot
		40 03482...	mm	W x H (mm)
<b>4931 W</b>	white	24740 2	375 x 384 x 145	360 x 32
<b>4932 Si</b>	silver	24750 1	375 x 384 x 145	360 x 32



# Letter boxes made of high-quality plastic



## Esprit

Letter box made of plastic in a dynamic shape. This modern model is optimally constructed. Extremely weatherproof.

Art.-No.	Colours	EAN	H x W x D	Slot
		40 03482...	mm	W x H (mm)
<b>4911 W</b>	white	24700 6	475 x 290 x 145	261 x 34
<b>4912 Si</b>	silver	24710 5	475 x 290 x 145	261 x 34



Esprit 4912 Si

## Vivo

Avant-garde letter box. A new dimension in form and function. Invisible locking system. Technically perfect construction. Extremely weatherproof.

Art.-No.	Colours	EAN	H x W x D	Slot
		40 03482...	mm	W x H (mm)
<b>4921 W</b>	white	24720 4	430 x 300 x 154	251 x 32
<b>4922 Si</b>	silver	24730 3	430 x 300 x 154	251 x 32



Vivo 4922 Si

## Paper box 4900

The perfect supplement to the new plastic letter boxes

Art.-No.	Colours	EAN	W x D x H
		40 03482...	mm
<b>4900 W</b>	white	32690 9	360 x 145 x 107
<b>4900 Si</b>	silver	32700 5	360 x 145 x 107



4900 Si

The letter boxes Esprit, Vivo and Classico are equipped with a special engaging lock for the door. After or while opening the door the key can be pulled off. In order to close the door it only needs to be pushed back.



Classico 4932 Si  
with matching paperbox 4900 Si



**BURG  
WÄCHTER**

## Letter boxes made of stainless steel



Milano 3843 ES

### Milano

Luxury stainless steel letter box, rustproof. This chic design model nestles perfectly against the wall.

**Dual application!** The newspaper partition and spacious letter compartment are located behind the tilting lid.

Art.-No.	EAN	H x W x D	Slot
	40 03482...	mm	W x H (mm)
<b>3843 ES</b>	32420 2	488 x 352 x 182	267 x 30



Interior lighting  
as a series



Dual application:  
2 compartments under  
one canopy

### Verona

Luxury stainless steel letter box, rustproof. New, innovative design. With integrated compartment for newspapers.

Art.-No.	EAN	H x W x D	Slot
	40 03482...	mm	W x H (mm)
<b>3844 ES</b>	32500 1	354 x 404 x 150	335 x 30



Verona 3844 ES



# Letter boxes made of stainless steel



## Hanseatic

Letter box made of hand polished natural finish stainless steel. Impresses through a simple design. Practical: includes letter box.

Art.-No.	EAN	H x W x D	Slot
	40 03482...	mm	W x H (mm)
<b>3816 Ni</b>	28860 3	350 x 440 x 180	330 x 35



Hanseatic 3816 Ni

## Westerland

Classic model made of hand polished natural finish stainless steel. Big volume and wide slot.

Art.-No.	EAN	H x W x D	Slot
	40 03482...	mm	W x H (mm)
<b>3882 Ni</b>	31030 4	345 x 410 x 205	330 x 35



Westerland 3882 Ni



## Modena 3857 Ni

Simple and elegant letter box made of stainless steel for external installation. With opening stop.

Art.-No.	EAN	H x W x D	Slot
	40 03482...	mm	W x H (mm)
<b>3857 Ni</b>	01740 1	335 x 360 x 127	325 x 33

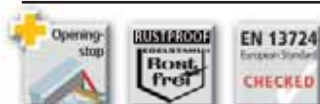

Modena 3857 Ni



**BURG  
WÄCHTER**

## Letter boxes made of stainless steel



Comfort 3913 Ni

### Comfort 3913 Ni

The letter box made of stainless steel with the extra comfort. More volume without additional price!

With opening stop for an easy and safe post removal. With interior lighting.

Art.-No.	EAN	H x W x D	Slot
	40 03482...	mm	W x H (mm)
<b>3913 Ni</b>	04190 1	340 x 380 x 148	332 x 32



### Amrum

Modern and timeless. Spacious stainless steel letter box with fold-out canopy, rustproof. A letter-holder keeps the post from falling out of the box.

Art.-No.	EAN	H x W x D	Slot
	40 03482...	mm	W x H (mm)
<b>3867 Ni</b>	08140 2	320 x 377 x 115	332 x 31



Amrum 3867 Ni



Lucca 3713 Ni Dekor

### Lucca 3713 Ni

Letter box made of stainless steel with translucent door and chromium-plated precision lock. Door made of break-proof, satinised plastic. Body made of stainless steel, sealing with scratch-resistant finish. Extra comfort: more volume, opening stop.



Art.-No.	EAN	H x W x D	Slot
	40 03482...	mm	W x H (mm)
<b>3713 Ni Letter</b>	14430 5	340 x 380 x 148	332 x 32
<b>3713 Ni Dekor</b>	14440 4	340 x 380 x 148	332 x 32





## Letter boxes made of stainless steel



Comfort 39130 Ni

### Comfort-Set 39130 Ni

A lot of space for letters, catalogues, newspapers. Post box made of stainless steel. With interior lighting for all models. Comfort depth 13 cm. Integrated paper box.

Art.-No.	EAN	H x W x D	Slot
	40 03482...	mm	W x H (mm)
<b>39130 Ni</b>	32680 0	440 x 380 x 148	332 x 32



### Amrum-Set

Modern and timeless. Spacious stainless steel letter box with fold-out canopy, rustproof. A letter-holder keeps the post from falling out of the box. With half-rounded paper box.

Art.-No.	EAN	H x W x D	Slot
	40 03482...	mm	W x H (mm)
<b>38670 Ni</b>	08150 1	420 x 377 x 115	332 x 31



Amrum-Set 38670 Ni

### Lucca-Set 37130 Ni

Letter box made of stainless steel with translucent door and chromium-plated precision lock. With integrated paper box. Door made of break-proof, satinised plastic. Body made of stainless steel, sealing with scratch-resistant finish. Extra comfort: more volume, opening stop.



Art.-No.	EAN	H x W x D	Slot
	40 03482...	mm	W x H (mm)
<b>37130 Ni Letter</b>	18080 8	440 x 380 x 148	332 x 32
<b>37130 Ni Dekor</b>	18090 7	440 x 380 x 148	332 x 32



Set Lucca 37130 Ni Letter



# Letter boxes made of stainless steel



Borkum 3877 Ni

### Borkum 3877 Ni

Simple, spacious letter box for outer use made out of stainless steel, rustproof.  
New: Execution perforated for installation in banks.

Art.-No.	EAN	H x W x D	Slot
	40 03482...	mm	W x H (mm)
<b>3877 Ni</b>	20200 5	322 x 362 x 100	333 x 34
<b>pre-drilled 3877 Ni</b>	20390 3	322 x 362 x 100	333 x 34



**Exemplar made of:**  
2 x Borkum 3877 Ni +  
2 x paper box 3820 Ni

### Borkum 3878 Ni

Simple, spacious letter box for fence fixing. Made of stainless steel, rustproof. With slot at the back. Scratch-resistant sealing.

Art.-No.	EAN	H x W x D	Slot
	40 03482...	mm	W x H (mm)
<b>3878 Ni</b>	18730 2	322 x 362 x 100	333 x 34



Borkum 3878 Ni



Hannover-Set 38610 Ni

### Hannover

Classic letter box of stainless steel, rustproof.



Art.-No.	EAN	H x W x D	Slot
	40 03482...	mm	W x H (mm)
<b>3861 Ni</b>	09480 8	305 x 225 x 75	190 x 30

### Hannover-Set

Compact letter box made of stainless steel with fitting paper box in a round shape. Can be used from both sides.



Art.-No.	EAN	H x W x D	Slot
	40 03482...	mm	W x H (mm)
<b>38610 Ni</b>	09580 5	305 x 225 x 75	190 x 30

# Letter boxes made of solid cast aluminium



Bordeaux 1895 W

## Bordeaux

Exclusive cast aluminium letter box offers great volume, with letter clip, absolutely weatherproof.

Art.-No.	Colours	EAN	H x W x D	Slot
		40 03482...	mm	W x H (mm)
1895 W	white	18150 8	480 x 425 x 180	330 x 32
1895 GR	green	18130 0	480 x 425 x 180	330 x 32
1895 BC	bronze	18110 2	480 x 425 x 180	330 x 32



## Ascona

Elegant cast aluminium letter box, weatherproof, offers great volume, with letter clip.

Art.-No.	Colours	EAN	H x W x D	Slot
		40 03482...	mm	W x H (mm)
1897 W	white	18950 4	425 x 425 x 180	330 x 32
1897 GR	green	18930 6	425 x 425 x 180	330 x 32
1897 BC	bronze	18910 8	425 x 425 x 180	330 x 32



Ascona 1897 BC



Venezia 1899 W

## Venezia

This solid cast aluminium letter box spreads a Mediterranean flair and natural elegance. Despite its aesthetic appearance this letter box offers a great volume for many letters.

Art.-No.	Colours	EAN	H x W x D	Slot
		40 03482...	mm	W x H (mm)
1899 W	white	31530 9	390 x 417 x 170	307 x 33
1899 BC	bronze	31510 1	390 x 417 x 170	307 x 33



## Paper box

The adequate paper box for all cast aluminium letter boxes.

Art.-No.	Colours	EAN	H x W x D
		40 03482...	mm
1890 W	white	12080 4	150 x 420 x 112
1890 GR	green	12060 6	150 x 420 x 112
1890 BC	bronze	12040 8	150 x 420 x 112



1890 BC



**BURG  
WÄCHTER**

## Letter boxes made of galvanized steel



Milano 843 W

### Milano

Luxury letter box made of galvanized steel – top quality coated.

**Dual application!** The newspaper partition and spacious letter compartment are located behind the tilting lid.

Art.-No.	Colours	EAN	H x W x D	Slot
		40 03482...	mm	W x H (mm)
<b>843 W</b>	white	32400 4	488 x 352 x 182	267 x 30
<b>843 BL</b>	blue	32410 3	488 x 352 x 182	267 x 30



Dual application:  
2 compartments under  
one canopy

### Roma 1842

Elegant letter box with relief front.

Art.-No.	Colours	EAN	H x W x D	Slot
		40 03482...	mm	W x H (mm)
<b>1842 K</b>	copper metallic	07540 1	355 x 390 x 135	262 x 38



Roma 1842 K



Roma 842 W

### Roma 842

Popular letter box made of galvanized steel in upto-date colours.

Art.-No.	Colours	EAN	H x W x D	Slot
		40 03482...	mm	W x H (mm)
<b>842 W</b>	white	07400 8	357 x 390 x 135	262 x 38
<b>842 WB</b>	white-blue	07940 9	357 x 390 x 135	262 x 38
<b>842 BR</b>	brown	12500 7	357 x 390 x 135	262 x 38
<b>842 S</b>	black	07410 7	357 x 390 x 135	262 x 38



# Letter boxes made of galvanized steel



## Sylt

Classic design! Spacious letter box with casted posthorn.

Art.-No.	Colours	EAN	H x W x D	Slot
		40 03482...	mm	W x H (mm)
<b>1883 W</b>	white	12810 7	345 x 410 x 205	330 x 35
<b>1883 K</b>	metallic copper	12830 5	345 x 410 x 205	330 x 35
<b>1883 E</b>	antique iron	12820 6	345 x 410 x 205	330 x 35



Sylt 1883 W

## Kopenhagen

Classic and elegant design.

Art.-No.	Colours	EAN	H x W x D	Slot
		40 03482...	mm	W x H (mm)
<b>882 W</b>	white	12730 8	345 x 410 x 205	330 x 35
<b>882 GR</b>	green	12710 0	345 x 410 x 205	330 x 35
<b>882 E</b>	antique iron	12700 1	345 x 410 x 205	330 x 35



Kopenhagen 882 GR



## Modena 857

Simple and elegant letter box for external installation.  
With opening stop.

Art.-No.	Colours	EAN	H x W x D	Slot
		40 03482...	mm	W x H (mm)
<b>857 W</b>	white	01720 3	335 x 360 x 127	325 x 33
<b>857 Si</b>	silver	01730 2	335 x 360 x 127	325 x 33
<b>857 ANT</b>	anthracite	18700 5	335 x 360 x 127	325 x 33



Modena 857 ANT





**BURG  
WÄCHTER**

## Letter boxes made of galvanized steel



Comfort 913 W

### Comfort 913

The letter box with the extra comfort. More volume without additional price!  
With opening stop for an easy and safe post removal. With interior lighting.

Art.-No.	Colours	EAN	H x W x D	Slot
		40 03482...	mm	W x H (mm)
<b>913 W</b>	white	04120 8	340 x 380 x 148	332 x 32
<b>913 Si</b>	silver	04150 5	340 x 380 x 148	332 x 32
<b>913 S</b>	black	04140 6	340 x 380 x 148	332 x 32



### Olymp

The letter box with the extra volume. Spacious letter box with a special character. Casing and flap are weatherproof galvanized and have a high quality coating. Big plastic canopy. Opening stop for the easy and safe post removal. Interior lighting.

Art.-No.	Colours	EAN	H x W x D	Slot
		40 03482...	mm	W x H (mm)
<b>916 W</b>	white	00900 0	340 x 389 x 193	332 x 32
<b>916 Si</b>	silver	00910 9	340 x 389 x 193	332 x 32



Olymp 916 Si



Futura 926 W

### Futura

The new letter box with the big volume and a lot of practical details. Casing and flap are weatherproof galvanized and have a high quality coating.

Big plastic canopy. Opening stop for the easy and safe post removal. Interior lighting.

Art.-No.	Colours	EAN	H x W x D	Slot
		40 03482...	mm	W x H (mm)
<b>926 W</b>	white	00920 8	340 x 389 x 188	332 x 32
<b>926 Si</b>	silver	00930 7	340 x 389 x 188	332 x 32





# Letter boxes made of galvanized steel



Comfort-Set 91300 Si

### Comfort-Set 91300

A lot of space for letters, catalogues, newspapers...

With interior lighting for all models. Comfort depth 13 cm. Integrated opening stop for an easy removal. With paper box.

Art.-No.	Colours	EAN	H x W x D	Slot
		40 03482...	mm	W x H (mm)
<b>91300 W</b>	white	32670 1	440 x 380 x 148	332 x 32
<b>91300 Si</b>	silver	32660 2	440 x 380 x 148	332 x 32
<b>91300 S</b>	black	32650 3	440 x 380 x 148	332 x 32



### Olymp-Set

Letter box with luxury features:

- interior lighting as a series
- comfortable depth 16 cm
- integrated opening stop

Steel casing with high-quality design canvas. Completely galvanized – high-quality coating. With integrated paper box.



Art.-No.	Colours	EAN	H x W x D	Slot
		40 03482...	mm	W x H (mm)
<b>91600 W</b>	white	32620 6	445 x 385 x 193	332 x 32
<b>91600 Si</b>	silver	32610 7	445 x 385 x 193	332 x 32



Olymp-Set 91600 W

### Futura-Set

Letter box with luxury features:

- interior lighting as a series
- comfortable depth 16 cm
- integrated opening stop

Steel casing with high-quality design canvas. Completely galvanized – high-quality coating. With integrated paper box.



Art.-No.	Colours	EAN	H x W x D	Slot
		40 03482...	mm	W x H (mm)
<b>92600 W</b>	white	32640 4	445 x 385 x 193	332 x 32
<b>92600 Si</b>	silver	32630 5	445 x 385 x 193	332 x 32



Futura-Set 92600 W



Futura-Set 92600 Si  
integrated opening stop in series



**BURG  
WÄCHTER**

## Letter boxes made of galvanized steel



Amsterdam 867 S

### Amsterdam

Sufficient space for your letters! Low-priced, spacious model at horizontal format. With canopy and letter insertion on the top.

Art.-No.	Colours	EAN	H x W x D	Slot
		40 03482...	mm	W x H (mm)
<b>867 W</b>	white	20230 2	320 x 377 x 115	332 x 31
<b>867 Si</b>	silver	31040 3	320 x 377 x 115	332 x 31
<b>867 GR</b>	green	20160 2	320 x 377 x 115	332 x 31
<b>867 BR</b>	brown	20250 0	320 x 377 x 115	332 x 31
<b>867 BL</b>	blue	20130 5	320 x 377 x 115	332 x 31
<b>867 S</b>	black	20240 1	320 x 377 x 115	332 x 31



### Set Vario

Letter box and paper box completely assembled as a unit. Letter box Amsterdam with attached paper box.



Set Vario 86720 BL

Art.-No.	Colours	EAN	H x W x D	Slot
		40 03482...	mm	W x H (mm)
<b>86720 W</b>	white	31420 3	420 x 377 x 115	332 x 31
<b>86720 Si</b>	silver	31440 1	420 x 377 x 115	332 x 31
<b>86720 BL</b>	blue	31430 2	420 x 377 x 115	332 x 31
<b>86720 S</b>	black	31460 9	420 x 377 x 115	332 x 31



Bayreuth 1867 K

### Bayreuth

Spacious letter box at horizontal format, with relief door.

Art.-No.	Colours	EAN	H x W x D	Slot
		40 03482...	mm	W x H (mm)
<b>1867 K</b>	copper metallic	08280 5	320 x 377 x 115	332 x 31





# Letter boxes made of galvanized steel



Magdeburg 767 W

## Magdeburg

Spacious and low-priced model with vertical format, with canopy.

Art.-No.	Colours	EAN	H x W x D	Slot
		40 03482...	mm	W x H (mm)
<b>767 W</b>	white	28960 0	396 x 301 x 115	250 x 33
<b>767 S</b>	black	28950 1	396 x 301 x 115	250 x 33



## Smart 4832

Simple letter box, slot under the canopy. Galvanized and varnished: white or black.  
Version Z: hot-dip galvanized.

Art.-No.	Colours	EAN	H x W x D	Slot
		40 03482...	mm	W x H (mm)
<b>4832 S</b>	black	31200 1	370 x 270 x 92	230 x 32
<b>4832 W</b>	white	31210 0	370 x 270 x 92	230 x 32
<b>4832 Z</b>	zinc coated	31280 3	370 x 270 x 92	230 x 32



Smart 4832 S

**Smart 4832 Z:**  
made from zinc coated steel,  
lead-free, eco-friendly production



## Piccobello 4861

Promotional model. Compact letter box with canopy.  
Galvanised and varnished: white or black.

Art.-No.	Colours	EAN	H x W x D	Slot
		40 03482...	mm	W x H (mm)
<b>4861 S</b>	black	31180 6	305 x 225 x 75	190 x 30
<b>4861 W</b>	white	31190 5	305 x 225 x 75	190 x 30



Piccobello 4861 W

## Letter boxes made of galvanized steel



Potsdam 877 W

### Potsdam 877

Low-priced large letter box for bank installation, with insertion on the front, horizontal format. A lot of space for your post! Perforated 877 W/Si: Execution perforated for installation in banks.

Art.-No.	Colours	EAN	H x W x D	Slot
		40 03482...	mm	W x H (mm)
<b>877 W</b>	white	20260 9	322 x 362 x 100	333 x 34
<b>877 Si</b>	silver	07750 4	322 x 362 x 100	333 x 34
<b>877 BR</b>	brown	20270 8	322 x 362 x 100	333 x 34



Potsdam 877 Si

Elegant and convenient letter box bank. A value for money solution from BURG-WÄCHTER.

#### Exemplar made of:

2 x Potsdam 877 W +  
2 x paper box Vario 820 W

The fastening of the paper box **on** the letter box is made with special glue strips.



### Leipzig 777

Low-priced, large letter box for bank installation, vertical format. Great volume for your letters! Perforated 777 W: Execution perforated for installation in banks.

Art.-No.	Colours	EAN	H x W x D	Slot
		40 03482...	mm	W x H (mm)
<b>777 W</b>	white	28930 3	397 x 284 x 104	252 x 30
<b>777 BR</b>	brown	28910 5	397 x 284 x 104	252 x 30



Leipzig 777 W

# Letter boxes for fence fixing



Leipzig 778 BR

## Leipzig 778

Letter box for fence fixing, inexpensive type at vertical format, with slot on the back. Also suitable for doors equipped with a letter plate.

Art.-No.	Colours	EAN	H x W x D	Slot
		40 03482...	mm	W x H (mm)
<b>778 W</b>	white	28970 9	397 x 284 x 104	252 x 30
<b>778 BR</b>	brown	28920 4	397 x 284 x 104	252 x 30



All letter boxes for fences are proper to be fixed on the interior side of a door leaf with insertion opening. The slot cover is removable without difficulties.

## Potsdam 878

Letter box for fence fixing, spacious and inexpensive, with slot at the back, at horizontal format. Also suitable for doors equipped with a letter plate.

Art.-No.	Colours	EAN	H x W x D	Slot
		40 03482...	mm	W x H (mm)
<b>878 W</b>	white	20490 0	322 x 362 x 100	333 x 34
<b>878 BR</b>	brown	20480 1	322 x 362 x 100	333 x 34



Potsdam 878 BR

## Borkum 3878 Ni

Simple, spacious letter box for fence fixing. Made of stainless steel, rustproof. With slot at the back. Scratch-resistant sealing.

Art.-No.	EAN	H x W x D	Slot
	40 03482...	mm	W x H (mm)
<b>3878 Ni</b>	18730 2	322 x 362 x 100	333 x 34

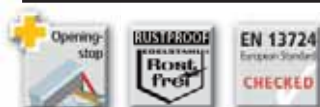

Borkum 3878 Ni

## Letter boxes Point

### Point: The new inexpensive letter box series

Quality made in Germany with a great price-performance ratio.

- model Journal and Mail according to EN 13724
- with cylinder lock and 2 keys
- made of galvanized sheet steel
- weatherproof
- baked enamel finish in up to 4 different colours
- colour iron: charcoal painting
- Mail also for banks



Pocket 5871 Si

Art.-No.	Colours	EAN	H x W x D	Slot
		40 03482...	mm	W x H (mm)
<b>Pocket 5871 E</b>	antique iron	61000 8	315 x 215 x 75	185 x 35
<b>Pocket 5871 W</b>	white	61010 7	315 x 215 x 75	185 x 35
<b>Pocket 5871 Si</b>	silver	61020 6	315 x 215 x 75	185 x 35

Art.-No.	Colours	EAN	H x W x D	Slot
		40 03482...	mm	W x H (mm)
<b>Mail 5877 E</b>	antique iron	61110 4	322 x 362 x 100	333 x 34
<b>Mail 5877 W</b>	white	61120 3	322 x 362 x 100	333 x 34
<b>Mail 5877 Si</b>	silver	61130 2	322 x 362 x 100	333 x 34



Mail 5877 W



Daily 5861 E

Art.-No.	Colours	EAN	H x W x D	Slot
		40 03482...	mm	W x H (mm)
<b>Daily 5861 GR</b>	green	61030 5	305 x 225 x 75	190 x 30
<b>Daily 5861 E</b>	antique iron	61040 4	305 x 225 x 75	190 x 30
<b>Daily 5861 W</b>	white	61050 3	305 x 225 x 75	190 x 30
<b>Daily 5861 Si</b>	silver	61060 2	305 x 225 x 75	190 x 30

Art.-No.	Colours	EAN	H x W x D	Slot
		40 03482...	mm	W x H (mm)
<b>Letter 5832 GR</b>	green	61070 1	370 x 270 x 92	230 x 32
<b>Letter 5832 E</b>	antique iron	61080 0	370 x 270 x 92	230 x 32
<b>Letter 5832 W</b>	white	61090 9	370 x 270 x 92	230 x 32
<b>Letter 5832 Si</b>	silver	61100 5	370 x 270 x 92	230 x 32



Letter 5832 GR

# Letter boxes Point, paper boxes



Art.-No.	Colours	EAN	H x W x D	Slot
		40 03482...	mm	W x H (mm)
<b>Journal 5867 E</b>	antique iron	61140 1	320 x 377 x 115	332 x 31
<b>Journal 5867 W</b>	white	61150 0	320 x 377 x 115	332 x 31
<b>Journal 5867 Si</b>	silver	61160 9	320 x 377 x 115	332 x 31



Journal 5867 E



Holiday 5842 Si

Art.-No.	Colours	EAN	H x W x D	Slot
		40 03482...	mm	W x H (mm)
<b>Holiday 5842 GR</b>	green	61170 8	357 x 390 x 135	262 x 38
<b>Holiday 5842 E</b>	antique iron	61180 7	357 x 390 x 135	262 x 38
<b>Holiday 5842 W</b>	white	61190 6	357 x 390 x 135	262 x 38
<b>Holiday 5842 Si</b>	silver	61200 2	357 x 390 x 135	262 x 38

**News 5800:** round shape, can be used from both sides.

Art.-No.	Colours	EAN	W x Ø
		40 03482...	mm
<b>News 5800 GR</b>	green	61210 1	W 400 Ø 120
<b>News 5800 E</b>	antique iron	61220 0	W 400 Ø 120
<b>News 5800 W</b>	white	61230 9	W 400 Ø 120
<b>News 5800 Si</b>	silver	61240 8	W 400 Ø 120



News 5800 W

## Inox-Star

Letter box made of stainless steel with paper box. Stainless steel rustproof. Canopy protects the mail from dampness. With cylinder lock and 2 keys. Paper box can be used from both sides. According to EN 13724.

Art.-No.	EAN	H x W x D	Slot
	40 03482...	mm	W x H (mm)
<b>InoxStar 4730 Ni</b>	07010 9	425 x 380 x 115	332 x 31



Inox-Star 4730 Ni

## Letter plates

### Porta letter plate, one-piece

Aluminium frame, galvanized lid, high-quality powder coating, fixing material incl.

Required opening:

Height: 50 - 67,5 mm, Width: 257 - 268,5 mm (model 796),

Width: 365 - 376,5 mm (model 797)

Can be used universally for doors/walls as from 20 mm thickness



Porta 796 A W



Porta 797 A W

Art.-No.	Colours	EAN	H x W	Slot
		40 03482...	mm	W x H (mm)
<b>796 W</b>	white	32470 7	101 x 304	35 x 254
<b>796 Si</b>	silver	32480 6	101 x 304	35 x 254
<b>796 BR</b>	brown	32490 5	101 x 304	35 x 254
<b>797 A W</b>	white	31560 6	101 x 412	35 x 360
<b>797 A Si</b>	silver	32380 9	101 x 412	35 x 360
<b>797 A BR</b>	brown	31570 5	101 x 412	35 x 360

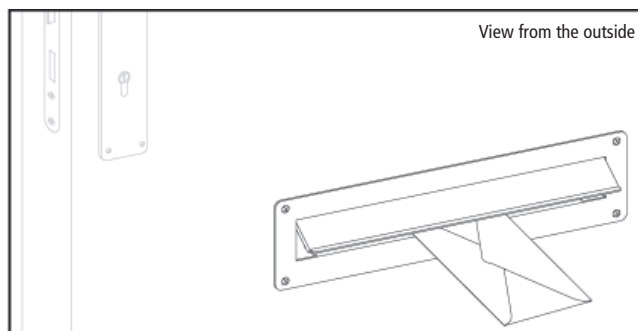

### Porta letter plate, two-piece

The perfect solution, consisting of inner and outer plates, aluminium frame, galvanized steel flaps, with special sealing, high-quality powder coating, fixing material incl.

Required opening:

Height: 50 mm - 80 mm, Width: 396 mm

Can be used universally for doors/walls from 25 to 60 mm thickness

Art.-No.	Colours	EAN	H x W	Slot
		40 03482...	mm	W x H (mm)
<b>798 Set W</b>	white	31580 4	101 x 412	35 x 360
<b>798 Set Si</b>	silver	32390 8	101 x 412	35 x 360
<b>798 Set BR</b>	brown	31590 3	101 x 412	35 x 360

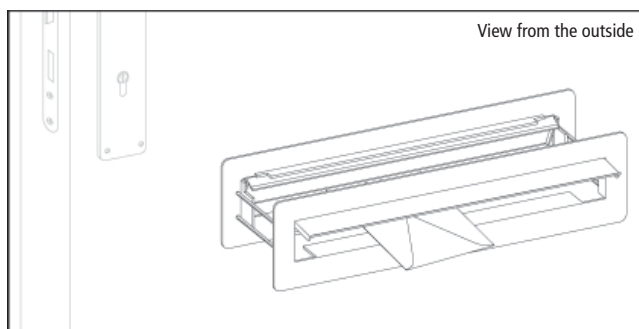

Porta 798 Set W



# Letter boxes for sealing in the wall



View from the outside:  
1 x box 795 + 1 x blind 794 W



View from the outside:  
2 x box 795 + 2 x blind 794 W

## Letter boxes for sealing in the wall

Letter box 795 made of galvanized sheet steel for sealing in the wall. Door varnished in white colour. Adjustable depth up to 490 mm wall thickness.

Art.-No.	Colours	EAN	H x W x D
		40 03482...	mm
<b>Kasten 795</b>	white / galvanized	32430 1	130 x 260 x 315 - 490



Adjustable depth: 315-490 mm

**794:** adequate blind for letter box 795. Front blind treaded, possibility to assemble as many letter boxes on top of each other as required.

Art.-No.	Colours	EAN	H x B	Slot
		40 03482...	mm	H x B (mm)
<b>794 W</b>	white	32440 0	135 x 305	35 x 230
<b>794 Si</b>	silver	32450 9	135 x 305	35 x 230
<b>794 BR</b>	brown	32460 8	135 x 305	35 x 230



View from the inside:  
2 x box 795 + 2 x blind 794 W

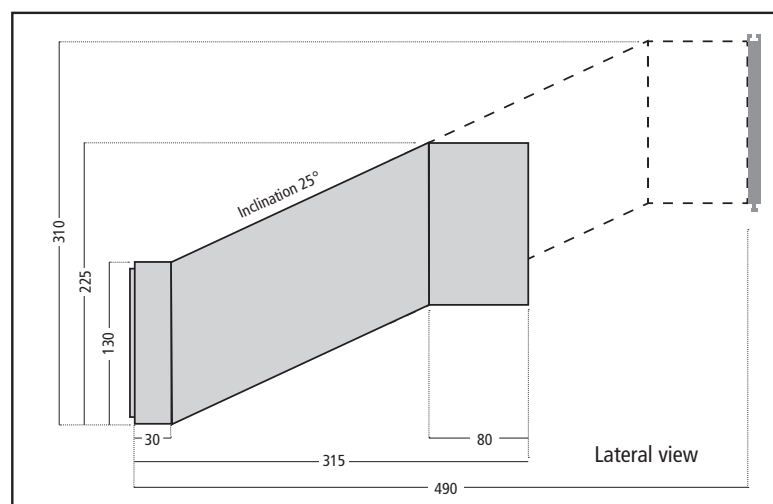

## Letter boxes for banks



Köln 872 W

### Köln

Standard letter box with insertion lid in 2 dimensions.

Art.-No.	Colours	EAN	H x W x D	Slot
		40 03482...	mm	W x H (mm)
<b>871 W</b>	white	13760 4	315 x 215 x 75	185 x 35
<b>871 BR</b>	brown	12520 5	315 x 215 x 75	185 x 35

Art.-No.	Colours	EAN	H x W x D	Slot
		40 03482...	mm	W x H (mm)
<b>872 W</b>	white	13770 3	340 x 255 x 85	225 x 35
<b>872 BR</b>	brown	12530 4	340 x 255 x 85	225 x 35

### Wismar

Standard model with uncovered slot, with viewing slots, for interior use.

Art.-No.	Colours	EAN	H x W x D	Slot
		40 03482...	mm	W x H (mm)
<b>771 W</b>	white	12930 2	315 x 215 x 75	185 x 35
<b>771 GRA</b>	grey	12610 3	315 x 215 x 75	185 x 35
<b>771 S</b>	black	12620 2	315 x 215 x 75	185 x 35

Art.-No.	Colours	EAN	H x W x D	Slot
		40 03482...	mm	W x H (mm)
<b>772 W</b>	white	28830 6	340 x 255 x 85	225 x 35



Wismar 771 GRA

**H x W x D:** Total dimensions height x width x depth in mm

**Slot:** Dimensions width x height in mm

Subject to changes in sizes and colouring as well as technical improvements.  
Minor variations of sizes depend on production characteristics.



# Letter boxes for banks



Leipzig 777 W



Potsdam 877 W



Borkum 3877 Ni



## Banks

The models Borkum, Leipzig, Potsdam and Köln in pre-drilled version are prepared for banks. Covers for unused mounting holes are included.

Frames for in-wall banks only.

Special packaging needed for banks as from 4 letter boxes onwards.

Art.-No.	EAN	H x W x D	Colours
	40 03482...	mm	
<b>pre-drilled 777 W</b>	27380 7	397 x 284 x 104	white
<b>pre-drilled 871 W</b>	13780 2	315 x 215 x 75	white
<b>pre-drilled 872 W</b>	13790 1	340 x 255 x 85	white
<b>pre-drilled 877 W</b>	20280 7	322 x 362 x 100	white
<b>pre-drilled 877 Si</b>	20800 7	322 x 362 x 100	silver
<b>pre-drilled 3877 Ni</b>	20390 3	322 x 362 x 100	
<b>frame 1 W</b>	09380 1	30 x 20 x 2	white
<b>assembly</b>	08370 3	per letter box	
<b>special packaging</b>	00100 4	per letter box	





## Paper boxes



800 W



800 Si

**800:** Round form with lateral plastic cover.

Art.-No.	Colours	EAN	W x Ø
		40 03482...	mm
<b>800 W</b>	white	13750 5	400 x 120
<b>800 WB</b>	white-blue	07640 8	400 x 120
<b>800 Si</b>	silver	31100 4	400 x 120
<b>800 BR</b>	brown	13710 9	400 x 120
<b>800 S</b>	black	13700 0	400 x 120

**808:** Square form with stamped lettering, useable width: 380 mm.

Art.-No.	Colours	EAN	W x D x H
		40 03482...	mm
<b>808 W</b>	white	20070 4	425 x 110 x 120
<b>808 GR</b>	green	12130 6	425 x 110 x 120
<b>808 BR</b>	brown	11790 3	425 x 110 x 120
<b>808 S</b>	black	11800 9	425 x 110 x 120
<b>808 K</b>	copper metallic-metallic	12150 4	425 x 110 x 120
<b>808 E</b>	antique iron	12140 5	425 x 110 x 120



808 BR



810 S

**810:** Square form with antique stamped lettering, useable width: 380 mm.

Art.-No.	Colours	EAN	W x D x H
		40 03482...	mm
<b>810 W</b>	white	08240 9	425 x 110 x 120
<b>810 BR</b>	brown	08230 0	425 x 110 x 120
<b>810 S</b>	black	08210 2	425 x 110 x 120

**Vario 820:** To be combined with the letter boxes Amsterdam or Potsdam. Fitting accessories included (4 screws, grommets and nuts + glue strips).

Fitting:

- under the letter box (fix with glue strips, then screwing)
- on the top of the letter box (with glue strips)
- not suitable for direct assembly on the wall

Art.-No.	Colours	EAN	W x D x H
		40 03482...	mm
<b>820 W</b>	white	31350 3	362 x 102 x 102
<b>820 Si</b>	silver	31370 1	362 x 102 x 102



820 W



1800 K

**1800:** Square form, with relief front, useable width: 380 mm.

Art.-No.	Colours	EAN	W x D x H
		40 03482...	mm
<b>1800 K</b>	copper metallic	08170 9	425 x 110 x 120

# Paper boxes



3800 Ni

**3800 Ni:** Round paper box with lateral cover, useable on both sides.

Art.-No.	Colours	EAN	W x Ø
		40 03482...	mm
<b>3800 Ni</b>	stainless	095409	400 x 120



**3808 Ni:**

Made of stainless steel, with lateral cover made of stainless steel, useable on both sides, useable width: 380 mm.

Art.-No.	Colours	EAN	W x D x H
		40 03482...	mm
<b>3808 Ni</b>	stainless	31010 6	425 x 110 x 120



3808 Ni



**3820 Ni:**

to be combined with the letter box models Amrum or Borkum. Fixing accessories included (4 screws, grommets and nuts + glue strips)

Fitting:

- under the letter box (fix with glue strips, then screwing)
- on the top of the letter box (with glue strips)
- not suitable for direct assembly on the wall

Art.-No.	Colours	EAN	W x D x H
		40 03482...	mm
<b>3820 Ni</b>	stainless	18820 0	362 x 102 x 102



3820 Ni



**1890:** Made from cast aluminium.

Art.-No.	Colours	EAN	W x D x H
		40 03482...	mm
<b>1890 W</b>	white	12080 4	420 x 112 x 150
<b>1890 GR</b>	green	12060 6	420 x 112 x 150
<b>1890 BC</b>	bronze	12040 8	420 x 112 x 150



1890 W

**4900:**

The perfect complement for the new plastic-letter boxes (see page 65).

Art.-No.	Colours	EAN	W x D x H
		40 03482...	mm
<b>4900 W</b>	white	32690 9	360 x 145 x 107
<b>4900 Si</b>	silver	32700 5	360 x 145 x 107



4900 Si



**BURG  
WÄCHTER**

## Letter boxes Europa



Europa 712 W

### Europa 712

Sufficient space for your letters!  
High-quality weatherproof letter box at vertical format,  
with large and totally projecting roof.



Art.-No.	Colours	EAN	H x W x D	Slot
		40 03482...	mm	W x H (mm)
<b>712 W</b>	white	20150 3	411 x 455 x 324	371 x 32
<b>712 E</b>	antique iron	20120 6	411 x 455 x 324	371 x 32

### Europa 731/732

Very useful and large letter box.  
At the top: compartment for letters with integrated insertion flap.  
At the bottom: spacious compartment for parcels with door for removal (magnetic lock).



Art.-No.	Colours	EAN	H x W x D	Slot
		40 03482...	mm	W x H (mm)
<b>731 W</b>	white	20030 8	360 x 405 x 292	371 x 32
<b>731 E</b>	antique iron	20020 9	360 x 405 x 292	371 x 32



Europa 731 E

**732:** Same model as 731 but with large and totally projecting roof.



Art.-No.	Colours	EAN	H x W x D	Slot
		40 03482...	mm	W x H (mm)
<b>732 W</b>	white	19850 6	411 x 455 x 324	371 x 32
<b>732 E</b>	antique iron	19840 7	411 x 455 x 324	371 x 32
<b>732 Si</b>	silver	19730 1	411 x 455 x 324	371 x 32



Europa 732 Si

### Stand for EUROPA

Aluminium stand for letter box EUROPA for setting in concrete, may be shortened to any desired length.

**ABE:** assembly set for wall fixing for all models Europa with roof

Art.-No.	Colours	EAN	H x W x D
		40 03482...	mm
<b>EST 1 W</b>	white	08270 6	1200 x 80 x 80
<b>EST 1 S</b>	black	08260 7	1200 x 80 x 80
<b>EST 1 Si</b>	silver	10910 6	1200 x 80 x 80
<b>A B E 1</b>		08290 4	



Europa 732 W  
with stand EST 1 W



# Freestanding letter boxes

## Jumbo 942

Stable, steady letter box with a big volume

- can be used variably for 1 or 2 users
- can be used with or without roof
- H x W x D without roof: 950 x 388 x 268 mm

Art.-No.	Colours	EAN	H x W x D	
			mit Dach in mm	W x H (mm)
<b>Jumbo 942 W</b>	white	19920 6	1070 x 482 x 305	327 x 32
<b>Jumbo 942 Si</b>	silver	19940 4	1070 x 482 x 305	327 x 32
<b>Jumbo 942 GR</b>	green	19930 5	1070 x 482 x 305	327 x 32



Jumbo 942 Si with roof



Jumbo 942 GR without roof

A lot of space for **many letters!**  
Slot format DIN C 4: 327 x 32 mm

### 2 in 1:

Two extra large letter boxes in one.  
Can be used variably for 1 or 2 users:  
**removable shelf** - thus you obtain an extra large compartment.

Galvanized and high-quality coated.  
Permanent **aeration system**.  
All pieces and assembly instruction included.

With drillings for **floor fixing**.  
These drillings are covered by the lower shelf.



▶ The **pointed roof** is included.  
Good protection, nice appearance.  
Easy installation from the inside.

▶ Here you can install a **cap** instead of the lid - in case the second lid is not used.





## Mailboxes, stands for letter boxes

### Original U.S. Mailbox

Letter box with red swinging flag offers great volume.

Art.-No.	Colours	EAN	H x W x D
		40 03482...	mm
<b>891 W</b>	white	18620 6	220 x 170 x 480
<b>891 S</b>	black	18610 7	220 x 170 x 480
<b>892 ALU</b>	from solid aluminium	18630 5	220 x 170 x 480



Mailbox 891 S  
with stand 893

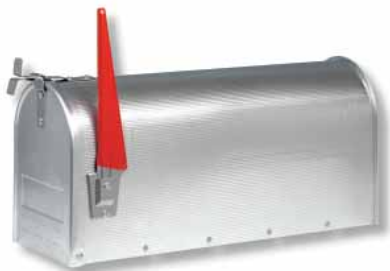

Mailbox 892 ALU

### Stand for U.S. Mailbox

Art.-No.	Colours	EAN	Height
		40 03482...	mm
<b>893 S</b>	black	18650 3	1500

### Rondo 145

Elegant semicircular stand with mounted fixing plate. Complete with fixing screws.

**Fitting letter boxes: Malmö, Bremen and Kiel.**



RONDO 145 W  
with letter  
box BREMEN

**Possible combination:**  
1 x Kiel 886 W +  
1 x Rondo 145 W

Art.-No.	Colours	EAN	Height	Ø
		40 03482...	mm	
<b>Rondo 145 W</b>	white	27760 7	1740	50





# Stands for letter boxes



Stand UNIVERSAL 150,  
view from reverse

## Universal 150

BURG-WÄCHTER letter box stand made of stainless steel/rustproof.

- Universal use for all letter boxes made of stainless steel, galvanized steel and plastic
- Consists of 2 tubes with special punching
- Letter boxes are secured from the inside onto the tubes, offering thereby increased theft protection
- To embed in concrete
- The tubes can be shortened as required
- This stand can also be fixed to a wall with usual pipe clips

Art.-No.	EAN	Height	Ø
	40 03482...	mm	mm
<b>Universal 150 Ni</b>	00300 8	1500	34

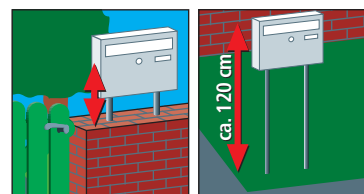

## UNI 190 NI

### Inox bow - to be attached to the Universal 150 Ni stand

Can be added to the stand also afterwards. Made of stainless steel.

Easy assembly:

- Remove the plastic cover plates
- Put the bow into both tubes of the Universal 150 Ni stand
- Fix the bow with the screws of the stand when fixing the letter box.

**Suitable for all models with a horizontal hole distance of 190 mm: Verona, Comfort/Comfort-Set, Lucca/Lucca-Set, Amrum/Amrum-Set, Modena, Borkum, Inoxstar, Olymp/Olymp-Set, Futura/Futura-Set, Amsterdam, Potsdam, Set Vario, Bayreuth, Classico**

Suitable for all models with a horizontal hole distance of 190 mm

Inox Bow  
UNI 190 Ni



Art.-No.	EAN	Ø
	40 03482...	mm
<b>Uni 190 Ni</b>	89060 8	34





## Letter box bank elements - freestanding



TERZO  
Combination  
example

### Letter box bank elements - freestanding

Stands, supports and canopies are produced of high-quality powder coated aluminium profile. To embed in concrete. With assembly instruction.

#### Terzo

Can be combined individually with supports, canopies and assembly sets. The programme for the handyman.

**Terzo V11 - Supports:** 110 mm profile, pre-drilled

**Terzo H14 - Canvas:** 140 mm profile, pre-drilled

Placing only in a weather-proof exterior area.

Art.-No.	EAN	Length	Colours
	40 03482...	mm	
<b>Terzo V11-160 W</b>	27720 1	1540	white
<b>Terzo V11-160 Si</b>	20530 3	1540	silver
<b>Terzo V11-180 W</b>	27730 0	1740	white
<b>Terzo V11-180 Si</b>	20540 2	1740	silver
<b>Terzo H14-63 W</b>	27360 9	630	white
<b>Terzo H14-79 W</b>	27700 3	790	white
<b>Terzo H14-79 Si</b>	20600 3	790	silver
<b>Terzo H14-92 W</b>	27370 8	920	white
<b>Terzo H14-115 W</b>	27680 8	1150	white
<b>Terzo H14-115 Si</b>	20620 1	1150	silver

### Letter boxes for self-assembly:

Leipzig 777, Potsdam 877 and Amsterdam 867 respectively Magdeburg 767 pre-drilled, incl. plugs. Also for wallmounted banks.

Art.-No.	EAN	H x W x D	Colours
	40 03482...	mm	
<b>pre-drilled 767 W</b>	28800 9	396 x 301 x 115	white
<b>pre-drilled 777 W</b>	27380 7	397 x 284 x 104	white
<b>pre-drilled 877 W</b>	20280 7	322 x 362 x 100	white
<b>pre-drilled 877 Si</b>	20800 7	322 x 362 x 100	silver
<b>pre-drilled 867 W</b>	27770 6	320 x 377 x 115	white
<b>pre-drilled 867 Si</b>	27710 2	320 x 377 x 115	silver

### Accessories

**Assembly sets:** Distance pieces, screws and washers packed for self-service packing unit: 5 pieces

**Terzo base for assembly on the ground:** Solid letter box made of high-quality zinc diecasting - no setting in concrete, incl. fixing material and plugs

Art.-No.	EAN	Colours
	40 03482...	
<b>Assembly set Terzo W</b>	05951 7	white
<b>Assembly set Terzo Si</b>	22081 8	silver
1 set per support, 1 set per canopy 63 or 92, 2 sets per canopy 79 or 115		
<b>Assembly set BK</b>	06871 7	
1 assembly set BK per letter box connection		
<b>Base V 11-F W</b>	31000 7	white
<b>Base V 11-F Si</b>	17780 8	silver
<b>Recommendation:</b> just screw it on a stable base plate, no setting in concrete		



TERZO  
Set 87410 Si

Terzo base:  
for a comfortable and stable  
screwing, without concrete  
or excavating works



TERZO  
base V 11-FW

# Examples for combining Terzo



**BURG  
WÄCHTER**

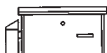

Built-in height:  
1301 mm  
Total height:  
1601 mm  
Width: 440 mm

Ref. 86400 W / 87400 Si  
Terzo installation with 1 letter box  
Amsterdam and 1 stand, consisting  
of:  
1 stand Terzo V11-160  
1 Amsterdam 867 perforated  
1 assembly set Terzo



Built-in height:  
1501 mm  
Total height:  
1801 mm  
Width: 440 mm

Ref. 86410 W / 87410 Si  
Terzo installation with 2 letter  
boxes and 1 stand, consisting of:  
1 stand Terzo V11-180  
1 Potsdam 877 perforated  
1 Amsterdam 867 perforated  
1 assembly set Terzo  
1 assembly set BK

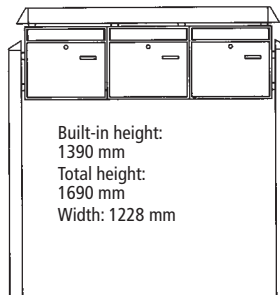

Built-in height:  
1390 mm  
Total height:  
1690 mm  
Width: 1228 mm

Ref. 86420 W / 87420 Si  
Terzo installation with 3 letter  
boxes Potsdam, consisting of:  
2 stand Terzo V11-160  
1 canopy Terzo H14-115  
3 Potsdam 877 perforated  
4 assembly sets Terzo  
2 assembly sets BK

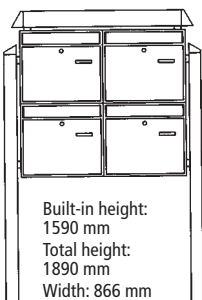

Built-in height:  
1590 mm  
Total height:  
1890 mm  
Width: 866 mm

Ref. 86430/87430 Si  
Terzo installation with 4 letter  
boxes Potsdam, consisting of:  
2 stands Terzo V11-180  
1 canopy Terzo H14-79  
4 Potsdam 877 perforated  
3 assembly sets Terzo  
4 assembly sets BK

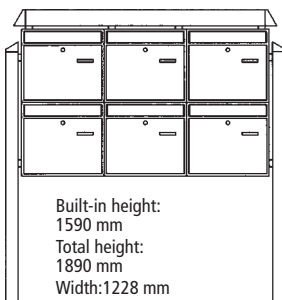

Built-in height:  
1590 mm  
Total height:  
1890 mm  
Width: 1228 mm

Ref. 86440 W / 87440 Si  
Terzo installation with 6 letter  
boxes Potsdam, consisting of:  
2 stands Terzo V11-180  
1 canopy Terzo H14-115  
6 Potsdam 877 perforated  
4 assembly sets Terzo  
7 assembly sets BK

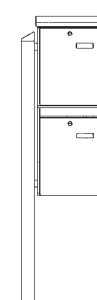

Built-in height:  
1501 mm  
Total height:  
1801 mm  
Width: 363 mm

Ref. 86460 W  
Terzo installation with 2 letter  
boxes and 1 stand, consisting of:  
1 stand Terzo V11-180 W  
1 Leipzig 777 W perforated  
1 Magdeburg 767 W perforated  
1 assembly set Terzo  
1 assembly set BK



TERZO  
Set-Nr. 86430

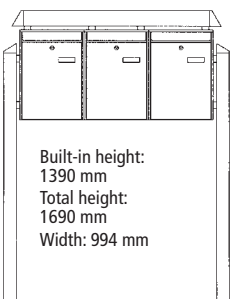

Built-in height:  
1390 mm  
Total height:  
1690 mm  
Width: 994 mm

Ref. 86470 W  
Terzo installation with 3 letter  
boxes Leipzig, consisting of:  
2 stands Terzo V11-160 W  
1 canopy Terzo H14-92 W  
3 Leipzig 777 W perforated  
4 assembly sets Terzo  
2 assembly sets BK

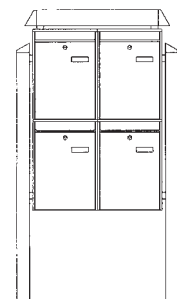

Built-in height:  
1590 mm  
Total height:  
1890 mm  
Width: 710 mm

Ref. 86480 W  
Terzo installation with 4 letter  
boxes Leipzig, consisting of:  
2 stands Terzo V11-180 W  
1 canopy Terzo H14-63 W  
4 Leipzig 777 W perforated  
3 assembly sets Terzo  
4 assembly sets BK

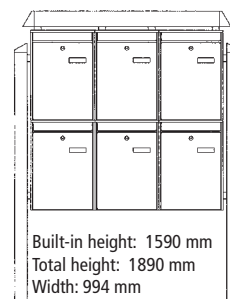

Built-in height: 1590 mm  
Total height: 1890 mm  
Width: 994 mm

Ref. 86490 W  
Terzo installation with 6 letter  
boxes Leipzig, consisting of:  
2 stands Terzo V11-180 W  
1 canopy Terzo H14-92 W  
6 Leipzig 777 W perforated  
4 assembly sets Terzo  
7 assembly sets BK



TERZO  
Set-Nr. 86440



## Accessories for letter boxes



PMF 1 SB



PMC 1 SB

### Special polish product for letter boxes

**Ferro-Star PMF 1 SB:** Special cleaning product for stainless steel letter boxes and other natural stainless steel surfaces

#### Color-Star PMC 1 SB:

Special cleaning product for varnished letter boxes made out of metal or plastic

**Regular application increases the lifetime of your letter box.**

Art.-No.	Colours	EAN	VE
		40 03482...	
PMF 1	SB	30121 0	5
PMC 1	SB	30111 1	5

- keeps the surface shiny
- offers extra protection against weather and environmental influences
- eliminates usage traces on the surface

### Spare cylinders

**ZBK:** single cylinders for replacement, for letter boxes of different brands

Art.-No.	EAN	VE	for
	40 03482...		
ZBK 70	22360 4	5	JU
ZBK 71	22370 3	5	Renz, Decayeux u.a.
ZBK 72	22380 2	5	Rombi, Knobloch
ZBK 73	22390 1	5	Brabantia (sheet metal)
ZBK 74	22680 3	5	Brabantia (plastic)
ZBK 70 SB	22361 1	5	JU
ZBK 71 SB	22371 0	5	Renz, Decayeux u.a.
ZBK 72 SB	22381 9	5	Rombi, Knobloch
ZBK 73 SB	22391 8	5	Brabantia (sheet metal)
ZBK 74 SB	22681 0	5	Brabantia (plastic)



ZBK 74



BK 92 M SB

- N1: standard name plate
- N2: for models Straßburg + Europa
- S1: sight plate for model Köln
- P1: postal horn, self-adhesive
- P2: postal horn for rivetting
- SD1: sight plate for paper boxes

### Accessories

Spare cylinders 92 M and 92 K for all BURG-WÄCHTER letter boxes.

Art.-No.	EAN	VE	Description
	40 03482...		
<b>SB</b> BK 92 M	14111 3	5	for all BURG-WÄCHTER letter boxes made of galv. steel
BK 92 K	14121 2	5	for all BURG-WÄCHTER letter boxes made of plastic and cast
BK 92 Point	30981 0	5	for Point metal letter boxes
BK 92 F	18661 9	5	2 name windows for letter boxes packed for self-service
<b>Bulk packed cylinders</b>		1	please note letter box model
<b>Name plate N1</b>	08110 5	5	size: 74 x 22 mm
<b>Name plate N2</b>	28900 6	5	size: 111 x 31 mm
<b>Sight plate S1</b>	08120 4	5	size: 44 x 14 mm
<b>Postal horn 1G</b>	28460 5	1	for Roma letter boxes
<b>Postal horn 2</b>	28470 4	1	for Sylt letter boxes
<b>Cover SD1</b>	28871 9	5	Ø 120 mm, packed in pairs 1 VE = 10 pairs



# Interpretation of the legend symbols

## Original BURG-WÄCHTER letter boxes

### Quality Made in Germany - approved according to the European norm EN 13724

What does the European norm "EN 13724" for letter boxes mean and which advantages are offered?

All letter boxes in this catalogue which are marked with the symbol "EN 13724" correspond to the high demands of the European standard and are recommended by the postal service.

The standard EN 13724 defines the size of the letter box, which means sufficient space for your post and the slot dimensions.

Furthermore the new European standard classifies the protection against breaking-in and corrosion.

Even the lock quality and resistance of rain-water penetration is tested.

In order to convey a clear overview of the quality of the particular letter box, BURG-WÄCHTER has developed a "Letter Box Passport" which contains the information of the following criteria corresponding to the demands of the new European standard EN 13724:

Category	Quality / feature	Pictogram
Type	1. for exterior use 2. for interior use 3. post insertion (wall assembly) 4. post insertion (door assembly)	
Format	1. landscape format 2. portrait format	
Corrosion resistance	0. no defined corrosion resistance 3. standard corrosion resistance 4. higher corrosion resistance	
Resistance against breaking-in	1. standard resistance against breaking-in 2. higher resistance against breaking-in	

Tip: To have more convenience and pleasure with your letter box, choose a model according to EN 13724 - this will be the right decision!



**BURG-WÄCHTER letter boxes with interior lighting.** Then you can easily pick up your letters even if it is dark outside.



**BURG-WÄCHTER letter boxes with comfortable depth.** For everybody who gets a lot of mail or wants to leave his letter box alone for a week.



**BURG-WÄCHTER opening stop:** The special hinge ensures a practical handling. The opening stop protects letters from dropping.



**BURG-WÄCHTER letter boxes made of high quality stainless steel** are extremely weatherproof and long-lasting. Stainless steel is a refined natural product which is durable throughout many decades without varnishing.

Concerns dimensions

**H x W x D:** Total dimensions height x width x depth in mm

**Slot:** Dimensions width x height in mm

## Colour table for letter boxes and paper boxes

### Letter boxes made of galvanized steel

Colours	Model
WHITE	nearly all models – similar to RAL 9016
SILVER	Amsterdam, Comfort, Europa, Futura, Modena, Olymp, Potsdam, Set Vario, Jumbo, ZB 800, ZB 820
GREY	Wismar – similar to RAL 7035
ANTHRACITE	Modena - similar to RAL 7016
GREEN	Amsterdam, Jumbo, Kopenhagen, ZB 808 – similar to RAL 6009
BROWN	Amsterdam, Köln, Leipzig, Potsdam, Roma, ZB 800, ZB 808, ZB 810 – similar to RAL 8014
COPPER METALLIC	Sylt, ZB 808
BLUE	Milano – similar to RAL 5002 Amsterdam, Set Vario, ZB 800 – similar to RAL 5011
BLACK	Amsterdam, Comfort, Magdeburg, Roma, Set Vario, Wismar, ZB 800, ZB 808, ZB 810 – similar to RAL 9005
ANTIQUÉ IRON	Europa, Kopenhagen, Sylt, ZB 808
COPPER	Bayreuth, Roma, ZB 1800

### Letter boxes made of high-quality plastic

Colours	Model
WHITE	nearly all models – similar to RAL 9003
SILVER	Atlanta, Classico, Esprit, Kiel, Swing, Vivo – similar to RAL 9006
GREEN	Bremen, Kiel – similar to RAL 6005
BROWN	Bremen – similar to RAL 8019
LIGHT-BLUE	Malmö – similar to RAL 5007
BLUE	Kiel – similar to RAL 5000
BLACK	Atlanta, Kiel – similar to RAL 9005
TERRACOTTA	Siena
GRAPHITE	Impression

### Letter boxes made of solid cast aluminium, structural surface

Colour	Model
WHITE	Ascona, Venezia – similar to RAL 9016
GREEN	Ascona – similar to 6005
BRONZE	Ascona, Venezia – similar to RAL 8025

Not every letter box is available in any colour. The possible colour variants are clearly indicated at every model. Due to the printing it is not possible to show the original colours a hundred per cent. The indicated RAL markings are only an approximate guideline.

Subject to errors or changes.